

## Technical documentation

### GIGA X8 Professional

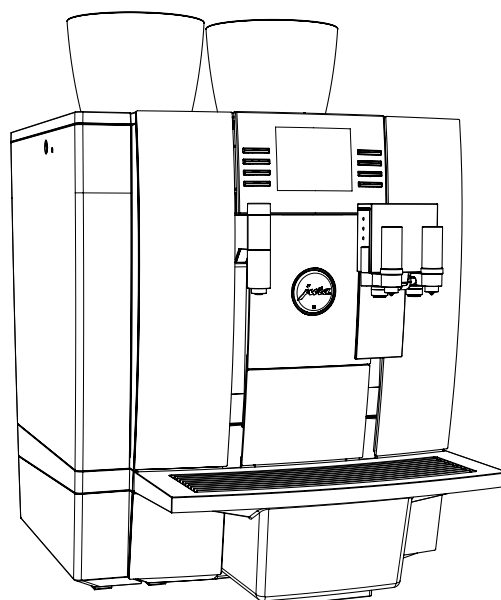

#### Supplied as standard

- Automatic speciality coffee machine
- Cappuccino cleaner, 1000 ml
- Welcome Pack:
  - Instructions for use
  - Cleaning tablets
  - Air intake pipe
  - Silicone hose and connector

#### Requirements for installation location

- Horizontal surface that is not sensitive to water
- Ambient conditions:
  - Air humidity max. 80%
  - Ambient temperature 10–35°C
- i** The required connections at the customer's premises must be carried out by an approved **qualified person** before the JURA service technician can set up the GIGA at your chosen location.
- i** Please make sure that the building connections are as close as possible to the location of the machine (refer to length of connection pipes).

Always note the information in the instructions for use for your coffee machine (Chapter 1 "Preparing and using for the first time" – "Setting up the machine").

## Dimensions

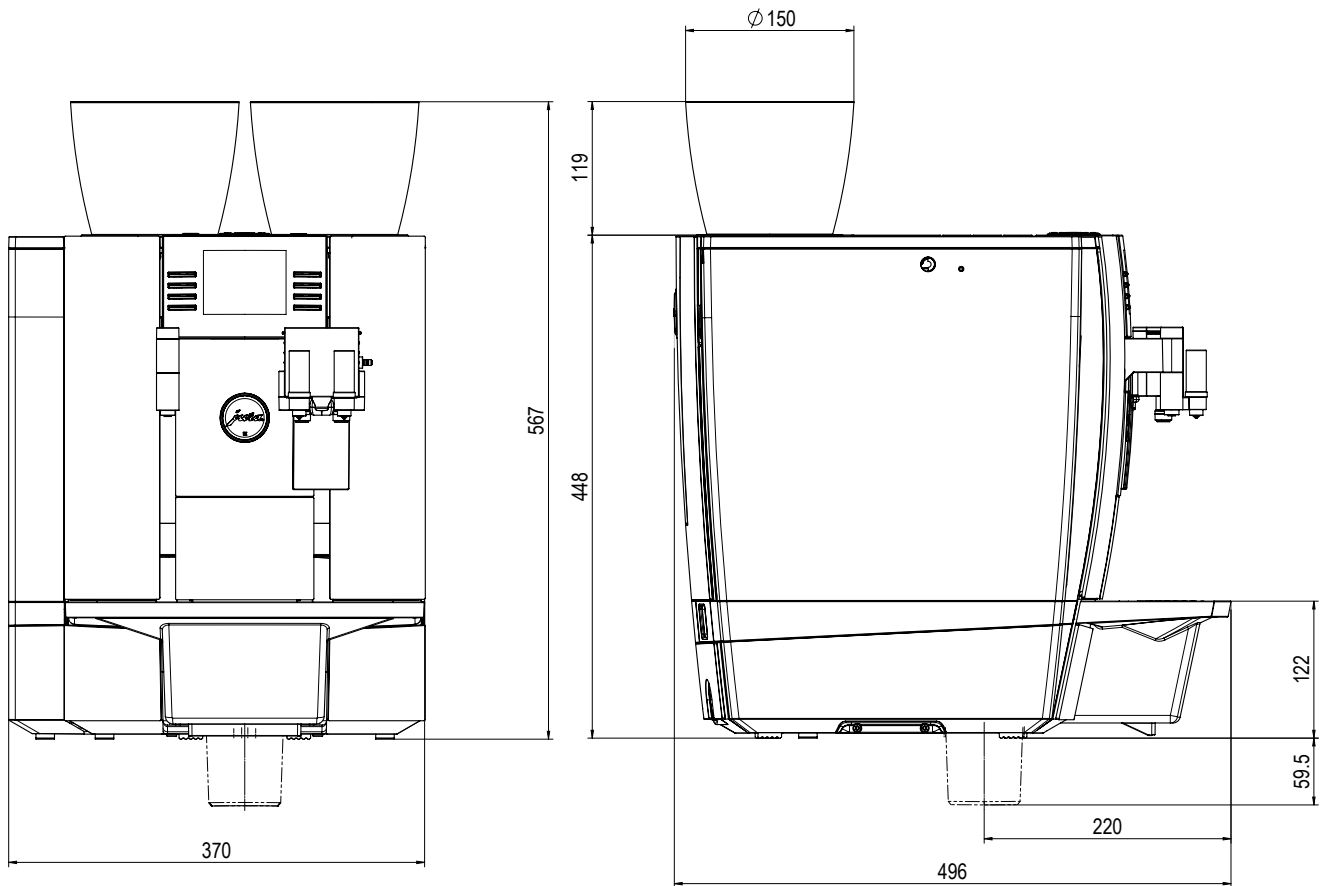

Outline

Side outline

## General space needed

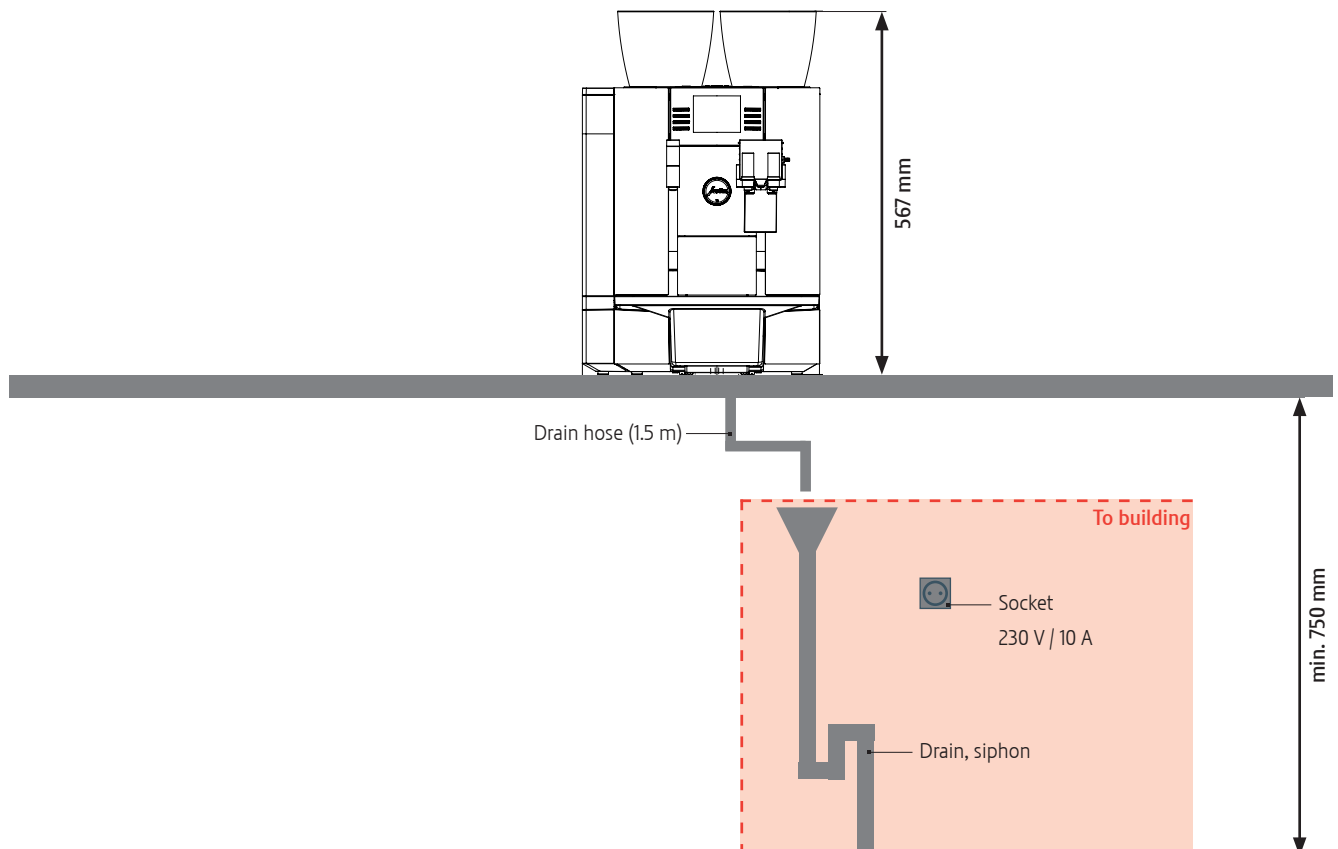

## Holes for coffee grounds disposal and drip drain set

### Position of hole in work surface for drain hose

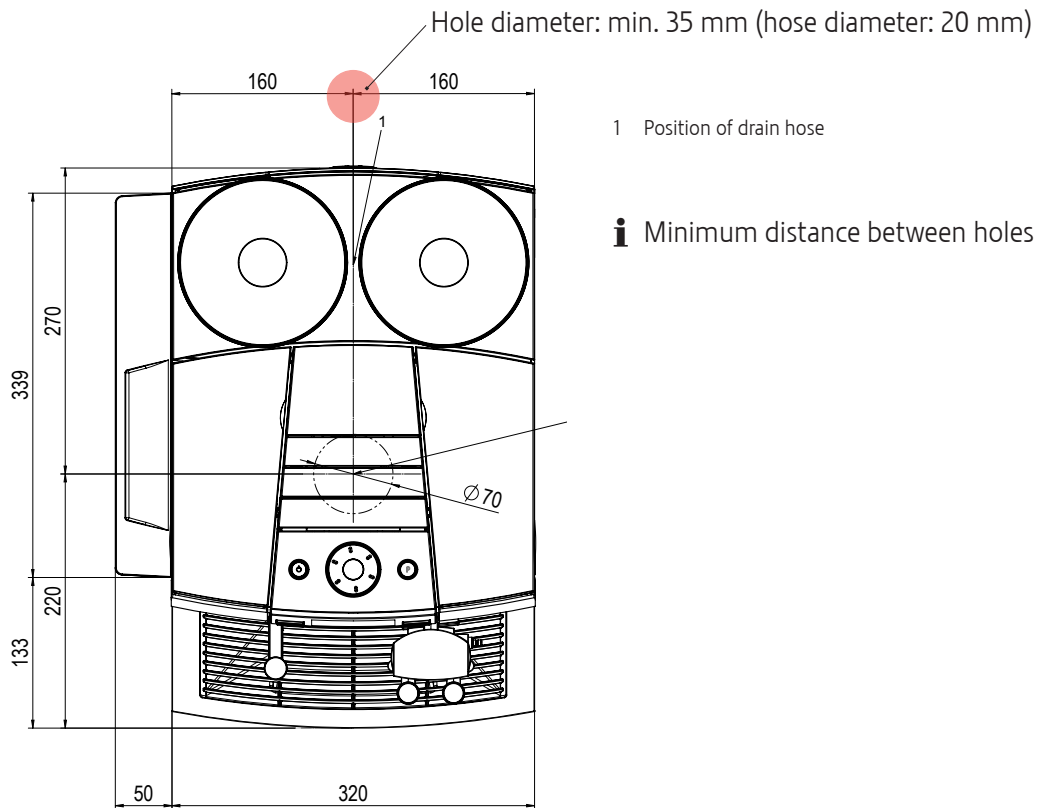

### Position of hole in work surface for coffee grounds disposal

